

The documentation supplied with the electrospindle comprises a dossier containing:

- Instruction for the correct installation, use and maintenance of electrospindle.
- Attached documents: overall dimensions, electrical specifications, power-torque speed diagram and other kind of documents if it is necessary.
- Constructor's declaration.

The Attachments are an integral part of the documentation and must be consulted in conjunction with this manual to avoid missing important information. Check that all above documents are present when the electrospindle is delivered. Ask Teknomotor S.r.l. for copies of any missing documents.

This manual has been written by Technical department – Teknomotor S.r.l., for use by all installers , operators and service technicians working with Teknomotor electrospindles.

Issued by	Code	Rev.	Approved by
Teknomotor S.r.l. Via Argenega,19 32030 Quero (BL)			

List of updates:

Rev.	Added	Deleted	Changed
1	2.4.1 – 2.4.2 - 8.5 – 8.6 – 8.7 – 8.8		29/03/2011

This manual is supplied together with the electrospindle. At its revision date, it was the most up to date documentation available on this product.

## SUMMARY

1. INTRODUCTION.....	34
1.1. PURPOSE.....	34
1.2. GENERAL SAFETY SYMBOLS.....	34
2. GENERAL INFORMATION.....	35
2.1. PROPER USE OF ELECTROSPINDLE.....	35
2.2. THE MAIN PARTS OF THE ELECTROSPINDLE.....	35
2.3. COOLING SYSTEM.....	37
2.4. TOOL FITTING.....	37
2.4.1. SHAFT BLOCKING.....	37
2.4.2. TOOL LOCKING.....	38
2.5. IDENTIFYNG THE MOTOR DATA FROM THE NAME PLATE.....	39
2.6. GENERAL CONDITION OF SALE.....	39
3. WARRING AND SAEFTY PRECAUTIONS.....	43
3.1. RISKS ASSOCIATED WITH IMPROPER USE AND HANDLING.....	44
3.2. RISKS SPECIFIC TO ELECTROSPINDLE MAINTENANCE.....	44
4. TECHNICAL SPECIFICATIONS.....	45
4.1. GENERAL VIEWS, OVERALL DIMENSIONS AND PERFORMANCE.....	45
4.2. MOTOR THERMAL PROTECTION.....	45
5. TRASPORT AND MOVING.....	45
5.1. PACKAGING AND LIFTING.....	45
5.2. STORAGE.....	46
6. INSTALLATION.....	46
6.1. CHECKING FOR DAMAGE.....	46
6.2. PROVISION OF ON SITE INSTALLATION EQUIPMENT.....	46
6.3. RUNNING IN.....	47
6.4. FIXING THE ELECTROSPINDLE.....	47
6.5. ELECTRICAL CONNECTIONS.....	47
6.6. ELECTRIC FAN.....	48
7. GENERAL CHECKS AFTER INSTALLATION IN THE MACHINE AND PRIOR START-UP.....	49
7.1. CHECKING ON THE ELECTROSPINDLE PRIOR TO START-UP.....	49
7.2. CHECKING ON THE ELECROSPINDLE AT THE TIME OF FIRST START-UP.....	50
8. OPERATION OF THE ELECTROSPINDLE.....	50
8.1. CLIMATIC LIMITATIONS.....	50
8.2. FORECAST AND NON FORECAST USE.....	50
8.3. WARMING UP.....	51
8.4. CHOOSING TOOLS.....	51

8.5.	TOOL MOUNTING – ELECTROSPINDLE WITH CONICAL SEAT FOR ER DIN 6499 .....	52
8.6.	MAXIMUM RUN-OUT AND VIBRATION VALUES .....	53
8.7.	TOOL MOUNTING – ELECTROSPINDLE WITH CILINDRICAL SHAFT .....	53
8.8.	DIFFERENT KIND OF TOOLS .....	54
9.	MAINTENANCE .....	55
9.1.	SCHEDULED MAINTENANCE AND CLEANING THE SPINDLE SHAFT TOOL HOUSING.....	56
9.2.	OCCASIONAL MAINTENANCE.....	56
10.	TROUBLESHOOTING .....	57
11.	DISPOSING OF THE ELECTROSPINDLE.....	57
12.	USEFULL ADRESSES.....	57

## 1. INTRODUCTION

### 1.1. PURPOSE

This manual contains important instructions and precautions, and must accompany the electrospindle at all times since it is essential for the safe operation of the electrospindle and operators.

Keep this manual safe, and ensure that all persons involved with the electrospindle know of it and have access to it.

The safety precautions contained herein are designed to ensure the safety of all persons exposed to the residual risks associated with the electrospindle.

The instructions contained herein provide information necessary for the correct operation of the electrospindle, as required by the manufacturer.



Make sure that you read and fully understand all the documentation supplied with the electrospindle to avoid incorrect operation of the unit and unnecessary risks of personal injury.

Keep this manual in a suitable place near the machine, where it will always be easily available to operators for consultation.

	<p><b>THE ELECTROSPINDLE MUST ONLY BE USED FOR THE PURPOSE FOR WHICH IT IS DESIGNED. SAFE OPERATION DEPENDS ON THIS.</b></p> <p><b>SAFETY ALSO DEPENDS ON CORRECT INSTALLATION OF THE ELECTROSPINDLE, AS DESCRIBED IN THE FOLLOWING SECTIONS OF THIS MANUAL.</b></p> <p><b>THE INFORMATION GIVEN IN THIS MANUAL IS THEREFORE ESSENTIAL TO ENSURE THAT THE ELECTROSPINDLE IS INSTALLED AND USED SAFELY AND CORRECTLY.</b></p>
---	--

### 1.2. GENERAL SAFETY SYMBOLS

In this manual, important instructions or precautions are marked with the following symbols:

	<b>IMPORTANT: IDENTIFIES PARTICULARLY IMPORTANT INFORMATION..</b>
	<b>WARNING-DANGER: IDENTIFIES SITUATIONS THAT COULD BE POSSIBLE ELECTRICAL SHOCK.</b>
	<b>WARNING-DANGER: IDENTIFIES SITUATIONS THAT COULD LEAD TO PERSONAL INJURY.</b>

## 2. GENERAL INFORMATION

### 2.1. PROPER USE OF ELECTROSPINDLE

The electrospindle is designed to operate as part of a machine.  
The frame of the machine to which it is fitted must be sufficiently rigid to provide adequate support for the weight of the electrospindle, and to withstand the stresses caused by machining.  
The electrospindles described in this manual are designed for the low-medium power milling and drilling of wood, fiberboard, plastic, aluminum, etc.. They are also designed for operation at S1 duty cycle unless special applications permit otherwise. (See data sheet.) Electrospindle technical specifications vary model by model. (See data sheet.)

This manual covers three series of electro spindle:

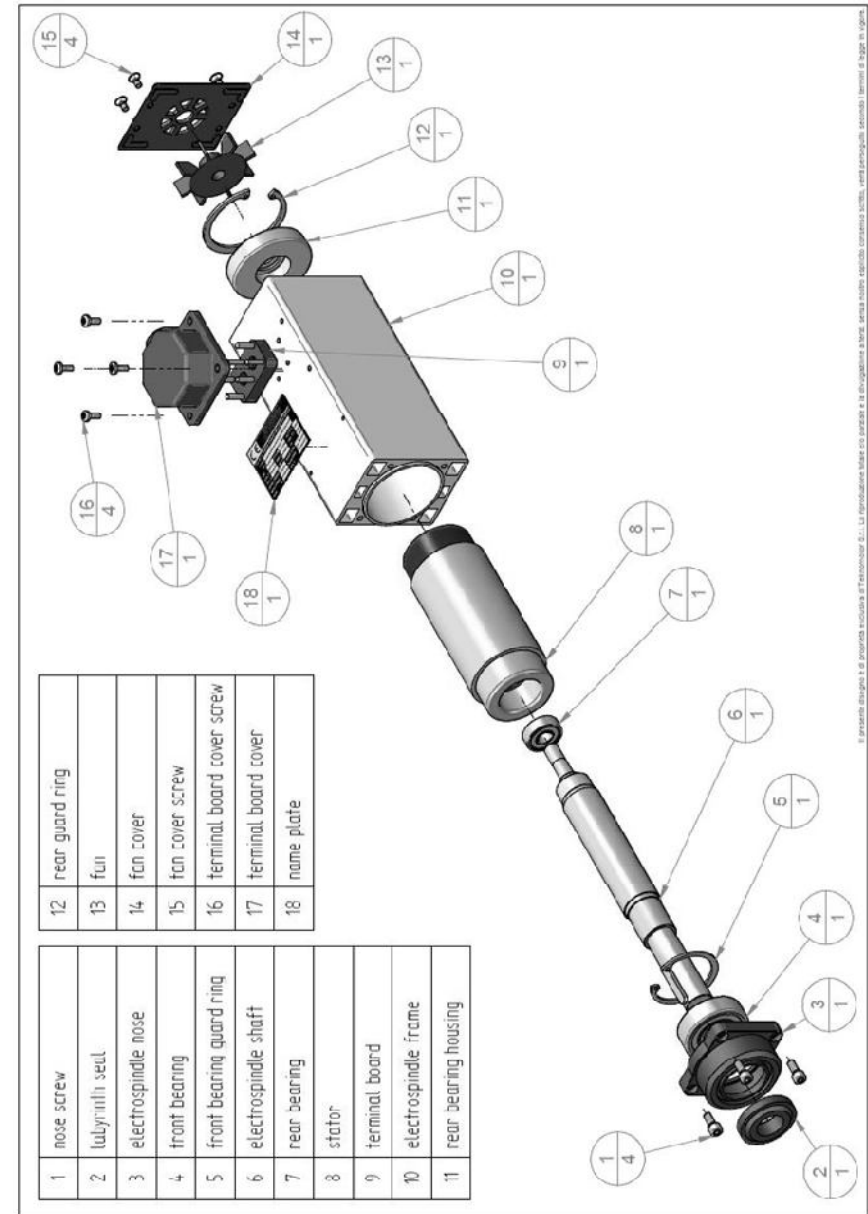
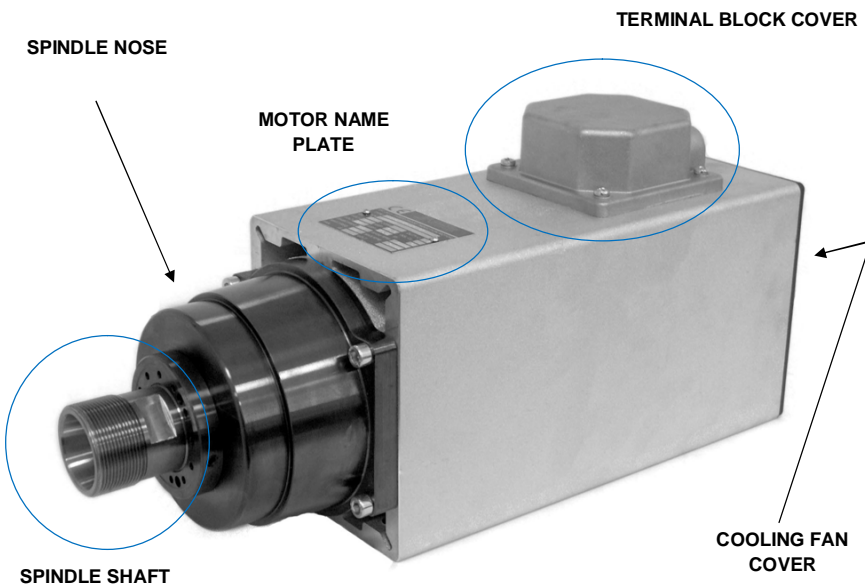

1. Electrospindles normally fitted with a front angular contact ball bearings and a rear single deep groove bearing.
2. Electrospindles fitted with two pair of angular contact ball bearings (front and rear).
3. Electrospindles fitted with two deep groove bearings (one front and one rear).

### 2.2. THE MAIN PARTS OF THE ELECTROSPINDLE



### 2.3. COOLING SYSTEM

In general, the electrospindle is forced air cooled by a fan under the rear cover. This fan is directly keyed on to the spindle shaft. Cooling efficiency therefore depends on spindle rotation speed. Cooling is effective only in one direction of rotation for shafts with ER-clamping system. Cooling is effective in both direction of rotation for cylindrical shafts.

	<b>THE COOLING FAN ARE DESIGNED BY TEKNOMOTOR S.R.L. AND PROVIDE MORE EFFECTIVE COOLING THAN TRADITIONAL AXIAL FANS.</b>
	<b>CONTACT TEKNOMOTOR TECHNICAL OFFICE BEFORE USING THE ELECTRO SPINDLE AT SPEED SIGNIFICANTLY LOWER THAN THOSE SPECIFIED ON THE ELECTRO SPINDLE DATA PLATE.</b>

### 2.4. TOOL FITTING

Various type of electrospindle shafts are available to cover most applications:

- Spindle shaft with flexible collet (ER16, ER20, ER25, ER32, ER40).
- Spindle shaft whit cylindrical fitting, key and externally threaded head.
- Spindle shaft whit cylindrical fitting, key and internally threaded head.
- Spindle shaft with special fitting.

All tool fitting types are manually operated.

	<b>THE TOOL EDGES ARE VERY SHARP AND CAN PROVOKE SERIOUS INJURIES. ALWAYS USE PROTECTION GLOVES, GOOGLES, CLOTHINGS, HELMETS AND OTHER PERSONAL PROTECTION EQUIPMENT (PPE) DURING THE TOOL FITTING OPERATION.</b>
---	---

#### 2.4.1. SHAFT BLOCKING

	<b>THE OPERATOR MUST ONLY FIT THE TOOL WHEN THE SPINDLE SHAFT IS STATIONARY (NO ROTATION).</b>
---	--

There are mostly four methods to block the shaft:

- Shaft blocking by rear hexagonal hole on the spindle shaft.
- Shaft blocking by front hexagonal hole on the spindle shaft.
- Shaft blocking by front flat on the spindle shaft.
- Shaft blocking by shaft blocking pin.

*Shaft blocking by rear hexagonal hole on the spindle shaft:* consist of an hexagonal hole made on the rear part of the shaft. The shaft is blocked by inserting the proper allen spanner into the hexagonal hole and keeping it steady.

*Shaft blocking by front hexagonal hole on the spindle shaft:* consist of an hexagonal hole made on the front part of the shaft. The shaft is blocked by inserting the proper allen spanner into the hexagonal hole and keeping it steady.

*Shaft blocking by front flat on the spindle shaft:* consist of a flat made on the front part of the shaft. The shaft is blocked by inserting the proper wrench into the flat and keeping it steady.

*Shaft blocking by shaft blocking pin:* consist of a spring loaded pin which penetrate the shaft in the specific hole. The pin is positioned in the motor near the spindle nose. Gently press the pin against the shaft and in the meantime manually rotate the shaft until the pin finds the proper hole into the shaft. At that point the pin will drop down and the shaft will be blocked. When releasing the blocking pin it must return to its original position thanks to internal spring.

	<b>BEFORE STARTING THE MOTOR BE SURE THAT THE BLOCKING PIN RETURNS TO ITS ORIGINAL POSITION AND THE SHAFT IS FREE TO ROTATE.</b>
---	--

#### 2.4.2. TOOL LOCKING

Once the shaft is blocked it is possible to mount/dismount the tool. The tool can be locked by ring nuts or by screws. Drive is transmitted from the spindle shaft to the tool either by friction (close contact) or by a key.

	<b>THE TOOL EDGES ARE VERY SHARP AND CAN PROVOKE SERIOUS INJURIES. ALWAYS USE PROTECTION GLOVES, GOOGLES, CLOTHINGS, HELMETS AND OTHER PERSONAL PROTECTION EQUIPMENT (PPE) DURING THE TOOL FITTING OPERATION.</b>
---	---

	<b>MAKE SURE THAT THE RING NUTS AND THE TOOL ARE TIGHT BEFORE STARTING THE ELECTRO SPINDLE.</b>  <b>ON VERSIONS FITTED WITH A TOOL ENGAGEMENT KEY, NEVER START THE ELECTRO SPINDLE WITHOUT A TOOL IN PLACE AND CORRECTLY TIGHTENED.</b>  <b>ON VERSIONS FITTED WITH A SHAFT LOCKING PIN, MAKE SURE THAT THE PIN IS FULLY DISENGAGED FROM THE SHAFT BEFORE STARTING THE ELECTRO SPINDLE. ALSO ALWAYS MAKE SURE THAT THE ELECTRO SPINDLE IS FULLY STATIONARY AND NOT POWERED ON BEFORE TURNING THE SHAFT AND ENGAGING THE PIN.</b>
--	--

## 2.5. IDENTIFYING THE MOTOR DATA FROM THE NAME PLATE

The part number (P.N. or TYPE) and the serial number (S.N.) are printed on the name plate and they are only way to identify the electrospindle recognized by the manufacturer. For this reason they must be kept legible throughout the unit's working life. The place of the name plate and the disposition of data in the name plate could be different model by model.

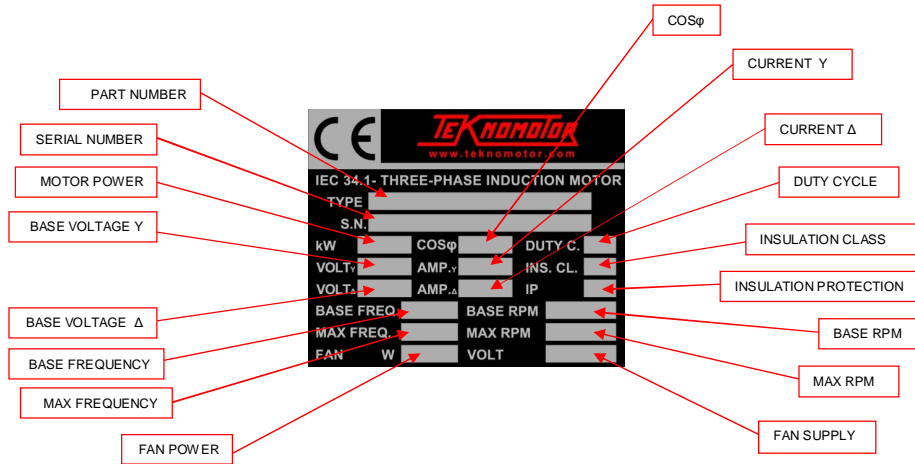

## 2.6. GENERAL CONDITION OF SALE

### FOREWORD

These General Conditions of Sale, except as specifically agreed between the Parties in writing: -shall regulate any present or future sales contracts, proposals/offers as well as any other agreement stipulated between Teknomotor S.n.c. (hereinafter "Seller" or "TM") and the Buyer or Customer; and -cancel and replace all previous conditions of sales of TM and constitute the reference basis for all agreements with the Buyer. Any general conditions of sale of the Buyer in contrast with the present provisions are not applicable except if confirmed by the Seller in writing.

### 1) STIPULATION AND EFFECTIVENESS OF THE AGREEMENT

The signing of a sales contract between the Parties, in whatever form, involves the Buyer's acceptance of these General Conditions of Sale.

The sales contract shall be considered as accomplished when, following receipt of an order conforming to the provisions under Art. 3 below, the Seller has sent the Buyer a written confirmation of it. Any matter not expressly or implicitly dealt with by the sales contract shall be ruled by: i) CISG (United Nations Convention on Contracts for the International Sale of Goods; ii) insofar as not covered by CISG, the law of the country where the Seller has its residence.

### 2) PRODUCT FEATURES

Any information or data regarding technical specifications and/or characteristics of the products contained in leaflets, pricelists, catalogues or similar documents shall be binding only if expressly mentioned and defined as binding in the sales contract.

The Seller reserves the right to alter the products insofar as, in its sole judgement, modifications are deemed necessary or recommended and providing they do not alter the fundamental features of the products. The Seller is not obliged to adapt, alter or withdraw the products from the market if legal regulations on the application, quality or use of the products are changed subsequently to the accomplishment of the agreement.

### 3) ORDERS

The Buyer's purchase order, however called, is always subject to written acceptance by TM. Notwithstanding the acceptance of telephone agreements, all orders must be subsequently sent and confirmed by the Buyer via facsimile, surface or electronic mail.

All subsequent order modifications must be notified in writing subject to the Seller's new written acceptance. The Seller's offer is to be deemed firm and irrevocable only if so stated in writing and if it specifically shows a validity term for the provision. Otherwise, it shall be considered not binding or as a mere reply to a quotation request. Any negotiations carried out by agents, licensees, representatives or sales assistants of the Seller are not binding for the latter until receipt of the Seller's express confirmation. Exclusively in case of materials not included in the Catalogue, i.e. in case of materials for which special agreements have been met between TM S.n.c. and the Customer, cancellation of the order by the Buyer involves TM's right to withhold any deposits paid by the Customer or to apply a penalty amounting to 20% of the value of the order, notwithstanding the Seller's faculty to ask for further damages.

### 4) DELIVERY TERMS AND DELAYED DELIVERY

Except if otherwise agreed upon in writing, sales are made "EX-WORKS" even when the full or partial shipment is organized by the Seller. All the delivery terms mentioned by the Seller are to be considered as purely indicative except if expressly mentioned as binding in writing. In case of non-fulfilment of the Customer's settlement obligations, the Seller shall have the right to change delivery terms. Delivery terms start from the date of receipt from the Seller of the deposit as provided by the sales contract. Any delay in delivery shall not in any case provide a reason for the Buyer to ask for damages, and the full effectiveness of the sales contract shall remain unchanged.

### 5) TRANSPORT, TRANSFER OF RISKS, FAULTS AND COMPLAINTS

In default of other agreements, the Seller shall choose the type of transport to be adopted, which is always at the Buyer's expense. The goods travel at the Buyer's risk, and the Seller waives any responsibility therefor from the moment the goods are released to the first carrier within the boundaries of Italy. Upon the Buyer's demand, the Seller may insure the goods against damage caused during transport. However, the Buyer must duly check the goods as soon as they have reached the Buyer's premises.

Any claim relating to package conditions, quantity, number or external appearance of the products ("obvious flaws") shall be notified to the Seller by registered letter (previously sent by facsimile) within eight (8) days from the date of receipt of the products, containing a detailed list of flaws and non-conformities. Later claims or claims not conforming to this clause shall be rejected.

Any claims relating to faults which could not be detected by accurate checking at the moment of receipt ("latent defects") shall be notified to the Seller by registered letter (previously sent by facsimile) containing a detailed list of faults and non-conformities within eight (8) days from the date of detection of those faults and anyway no later than twelve (12) months from delivery. Failure to observe these conditions shall lead to the rejection of such claims.

Any return of the goods by the Buyer shall only be accepted if previously authorised by the Seller. In case the Buyer has used the goods or altered their condition in such a way that the Seller cannot check them, the Buyer shall have no right to make any claim. Whenever a claim has resulted to be unfounded, the Buyer shall also refund the Seller for any costs incurred for the checking of the products. It is understood that any claim or dispute directly or indirectly relating to the products shall give the Buyer no right to interrupt or delay payments of the products involved nor of any other supplies with pending payments.

#### 6) PRICES AND PAYMENTS

All prices are meant EX-WORKS (Seller's premises). Prices shall be increased of the applicable value added tax and any other enforceable tax.

Prices are inclusive of normal packing, whereas they do not include customs duties, transport or insurance costs.

Current prices are mentioned in observance of the Seller's specifications and remain valid until the relevant pricelist updating.

Notwithstanding the above, the Seller reserves the right to alter prices in the short term in case of increase in costs applied by the Seller's own suppliers.

In case of increase in raw material costs, the Seller is entitled to update prices provided the Buyer is informed of such updating, and the Buyer shall have the right to cancel orders within 3 days from receipt of such notification.

Payments shall be addressed by the Buyer to the Seller's premises no later than the terms established by TM and made by bank transfer following the Seller's instructions. Invoices shall be paid in full with no deductions except if justified by a Credit Note issued by the Seller.

In case of delayed payments, even of one single instalment, the Buyer's right to deferred terms shall cease without any formal notification by the Seller as provided by Art. 1186 of the Italian Civil Code, and the Buyer shall pay the Seller a penalty interest amounting to the applicable rate as provided by the Law plus 8%, within the threshold admitted by Act no. 108/96, notwithstanding any further claims for damages that the Seller may make.

#### 7) LIEN AGREEMENT

The ownership of the products shall only be transferred to the Buyer after full payment of the goods supplied including any interests, if due. The Buyer undertakes to stock such goods separately and with due diligence and to mark them clearly as the Seller's property. The Buyer also undertakes to assist the Seller in taking all necessary measures to protect the Seller's rights.

This lien agreement does not affect the transfer of risks as stated under 5 above.

If the law of the State where the goods are stored does not admit the right to retain ownership, a form of guarantee similar to this and enforceable in that State shall be applied. If, in order to make this guarantee enforceable, the Buyer's action is required, the Buyer shall take all necessary measures to adopt and maintain this guarantee.

#### 8) WARRANTY

Within the limits of the following provisions, the product is guaranteed for one (1) year (12 months) against material, working and manufacturing faults. Any guarantee on faults not to be attributed to the Seller is excluded. During the guarantee period, starting from the day of transfer of risks, the Seller shall only have the obligation, at its own discretion, to either i) repair any faulty products on the spot, or ii) repair any faulty parts free of charge provided the product or part of it has been returned, or iii) send a product or part of it similar to the faulty one as a replacement. Whenever the Seller asks for any faulty goods to be returned for replacement or repair, the Buyer assumes, except if otherwise agreed, any transport freight or risk (delivery "carriage free").

The Seller's responsibility is limited to faults arising in the usage conditions as specified in the sales contract and upon correct use of the parts involved. It does not cover, in particular, any faults deriving from wrong installation, maintenance or repair made by anyone other than the Seller or the Seller's authorized staff, nor any alterations made without the Seller's written consent or due to normal wear and tear. Except in the case of willful misconduct or gross negligence, the Seller shall only be bound, in case of vices, quality loss or non-conformity of the products, to repair the same and supply replacements for them as above specified.

It is agreed that the above guarantee, i.e. the Seller's obligation to repair or replace the products, incorporates and replaces any guarantee or liability as provided by the law and excludes any other contractual or tortious liability however arising from the finished products, including, without limitation, refund of damages, gain loss, collection campaigns, idle time losses, loss of clientele or damaged reputation, etc.

The products or their faulty parts which have been replaced according to the provisions stated herein shall be made available to the Seller for the time necessary for checking.

The greatest liability of the Seller, also in case of non-predictable damage, shall in no case exceed the price of the faulty product. For no reason shall the Buyer ask for damages for interruptions of its business activity. In no case Teknomotor S.r.l. or its suppliers shall accept any responsibility for damage (including but not only, damage to the unit, damage incurred for lost production and income, down-time in manufacturing, loss of information or other economic losses) deriving from the use of Teknomotor products, even if Teknomotor has been advised of such risks in advance.

The Seller shall not accept any return of goods if not previously authorized in writing. The goods which have been authorized for return shall be accompanied by a relevant DDT (Document of Transport, or equivalent), a description of the problem, and a specific indication of how the product was used. In case the Seller has committed itself to repair the product, the cost for its shipment back to the Buyer is entirely at the Buyer's charge.

The warranty becomes automatically null and void if the customer fails to notify Teknomotor S.r.l. in writing of any faults found in the electrospindle within 15 days of their occurrence. The warranty likewise becomes null and void if the customer fails to permit the electrospindle's seller to perform all necessary checks and tests, and if, when the seller requests the return of the defective electrospindle, the customer fails to do so within two weeks of the request.

The warranty does not cover faults arising from wear of parts normally subject to continuous or rapid wear (e.g.: seals, belts, bearings, etc.). In particular Teknomotor S.r.l. provides no guarantee as to the working life of the unit's bearings since this depends on a number of factors such as tool balance, type of machining operation, impacts, and/or other mechanical stresses not specified by the customer.

Dimensioned drawings and photographs are provided only for information purposes and to facilitate understanding of text.

Teknomotor S.r.l. has a policy of constant development and improvement, and reserves the right to make functional and stylistic modifications to its products, to change the design of any functional or accessory part, and to suspend manufacturing and supply without notice and without obligation to third parties. Furthermore, Teknomotor S.r.l. reserves the right to make any structural or functional change to the units, and to change the supply of spare parts and accessories without any prior notice.

Teknomotor S.r.l. declines all responsibility for non-compliance of the electrospindle caused by failure to follow the precautions and instructions given in this manual or by improper use or handling of the electrospindle. The customer has the right to replacement of all parts shown to be defective, unless the defects are caused by unauthorized tampering, including the fitting of non-original Teknomotor spare parts and/or the replacement of parts not described or authorized in this manual unless authorized beforehand and in writing by Teknomotor S.r.l.

#### 9) FORCE MAJEURE

Either Party shall have the faculty of suspending the execution of their contractual obligations when such execution is made impossible or unreasonably costly by an unpredictable event which goes beyond the Parties' will such as, for example, suppliers' non-performance of duties, energy or raw material shortages, strikes, lock-outs, declared or non-declared war, civil war, terrorist acts, embargoes, etc.

The Party wishing to enforce this clause shall immediately notify the other Party in writing of the beginning and the end of such circumstances of force majeure.

Whenever the force majeure event lasts more than 6 weeks, either Party shall have the right to rescind the contract with a written notice sent to the other.

#### 10) LIABILITY

The Seller shall not be held liable for damage or accidents to things, people, or loss of gain deriving from the use of its motors.

#### 11) COOPERATION BETWEEN THE PARTIES

The Buyer shall promptly inform the Seller of any claim forwarded to the Buyer by its customers or by third parties regarding the products delivered or intellectual property rights on them.

## 12) SEVERANCE CLAUSE

Whenever one or more provisions contained herein are declared void based on the Buyer's local legislation, the Buyer is obliged to promptly inform the Seller and, in such case, those void provisions shall be modified in writing by adding an appendix hereto which shall be construed in such a way as to have the nearest possible financial purpose of the original one(s), whereas the provisions not declared as void shall remain binding.

## 13) INTELLECTUAL PROPERTY

Except if otherwise agreed between the Parties, the Buyer does not acquire any intellectual property right on any software packages and/or drawings released to it by the Seller. The Buyer undertakes to treat any information received by the Seller as confidential. The Seller remains the only owner of any intellectual property right relating to the products.

## 14) TRANSFER OF RIGHTS TO THIRD PARTIES

The Buyer shall not transfer or assign this agreement or any of the rights originating from it to any third parties without the Seller's written consent.

## 15) LANGUAGE OF THE SALES CONTRACT

The sales contract and the present General Conditions of Sale are originally drawn up in Italian and have full value in this language, whereas any versions in other languages shall be intended as informal translations. Only the version in Italian shall constitute a reference in case of disputes relating to the content or effectiveness of a clause contained herein.

## 16) PLACE OF JURISDICTION

The applicable law is the Law of Italy. Any dispute arising directly or indirectly from the contractual relationship between the Parties shall be exclusively submitted to the Court of Belluno, Italy, notwithstanding the faculty of the Seller only to file a lawsuit before the Buyer's competent Court.

## 3. WARRING AND SAEFTY PRECAUTIONS

	<b>TEKNOMOTOR S.R.L. DOES NOT AND CANNOT KNOW HOW END USERS WILL INSTALL THEIR ELECTROSPINDLES. THE INSTALLER OR CUSTOMER MUST THEREFORE PERFORM RISK ASSESSMENT SPECIFIC TO EACH INSTALLATION AND APPLICATION.</b>
--	---

It is also the responsibility of the installer to ensure that adequate guards are provided to prevent accidental contact with moving parts.

The installer and the operator must also bear in mind other types of risk, particularly those associated with foreign bodies, explosive, inflammable, toxic or high temperature gasses.

Risks associated with maintenance operations must also be guarded against. Maintenance must be performed in conditions of maximum safety, and only with the electrospindle fully stationary and switched off.

Once the electrospindle has been installed in the way decided upon by the installer and/or customer, the machine becomes a "finished machine" as defined for the purposes of the Machinery Directive. Overall risk assessment must therefore be performed on the finished machine and a declaration of conformity produced in compliance with Appendix IIA of the 98/37/CE Machinery Directive.

## 3.1. RISKS ASSOCIATED WITH IMPROPER USE AND HANDLING

- Never impede the functioning of, remove, modify or in any way interfere with any safety device, guard, or control of individual parts or of the electrospindle as a whole.
- Never place your hands, arms, or any other part of your body near moving machinery.
- Never push objects through the cover grill or into the electrospindle either when it is stationary or when it is operating.
- Do not use the electrospindle in atmospheres or environments where there is a risk of explosion.
- Unless you are duly authorized, never attempt to repair faults or electrospindle malfunctions and never interfere in any way with the electrospindle's operation or installation.
- On completion of servicing work for which guards, covers, or any other protections have been removed, always make sure that they have been correctly and securely replaced and are fully functional before re-starting the electro spindle.
- Keep all protection and safety devices in perfect working order. Also make sure that all warning and informative plates, labels and symbols are correctly positioned and perfectly legible.
- When troubleshooting the electrospindle always adopt all the safety precautions listed in this manual for the purpose of preventing injury or damage to persons and things.
- After adjusting any mechanical part, make sure that you fully tighten all screws, bolts or ring nuts you may have slackened or removed.
- Before you start the electrospindle, make sure that all the safety devices are installed and perfectly functional. Do not start the electrospindle if this is not the case, but immediately inform the person responsible for machine safety or your direct superior.
- Make sure that you have and use all the personal protective equipment (PPE) required by law. Do not wear loose or hanging clothing (ties, wide sleeves, etc.).
- Never start electrospindles fitted with tool engagement keys unless a tool is in place and correctly locked. In particular make sure that the key engages the tool correctly.

## 3.2. RISKS SPECIFIC TO ELECTROSPINDLE MAINTENANCE

- During all maintenance and cleaning operations, take great care if a tool is fitted. It is advisable to remove any tool before starting cleaning or maintenance.
- The electrospindle can still turn under the effect of inertia even after it has been switched off. Make absolutely sure that the electrospindle is not still spinning before starting any maintenance on it.
- Perform scheduled maintenance as specified in this manual to avoid the risk of mechanical failures from advanced wear.

	<b>NEVER START ANY MAINTENANCE BEFORE MAKING ABSOLUTELY SURE THE ELECTROSPINDLE IS STOPPED SPINNING.</b>
	<b>NEVER START ANY MAINTENANCE ON THE ELECTROSPINDLE WITHOUT DISCONNECTING IT FIRST FROM THE ELECTRICAL POWER SUPPLY.</b>
	<b>NEVER ATTEMPT TO CLEAN THE ELECTROSPINDLE WHILE IT IS ROTATING.</b>

## 4. TECHNICAL SPECIFICATIONS

### 4.1. GENERAL VIEWS, OVERALL DIMENSIONS AND PERFORMANCE

See attached documents. If the document is not available please contact our technical office.

### 4.2. MOTOR THERMAL PROTECTION

Thermal Protection is an important protection in motors. Motors can get heated due to overloading, high ambient temperature, variations in power quality, etc. Thermal overload can result in stator overheating, faulty operation and in some extreme cases even fire. Hence, all motors need to be fitted with protection against thermal overload.

#### PTC THERMISTOR:

In some types of electrospindles it could be inserted a PTC thermistor in the stator windings to monitor temperature. Electrical resistance of the thermistor increases rapidly as it reaches trip temperature (normally 100°C or 130°C depending on the model).

The signal of the thermistor must be fed to a control device to stop the machine in order to protect the electrospindle from the effects of overheating.

Thermistor trip temperature depends on the model of electrospindle. For more information call Technical office – Teknomotor S.r.l.

#### BIMETALLIC THERMAL PROTECTION:

In some types of electrospindles it could be inserted a bimetallic thermal protection in the stator windings. The electrical contacts are interrupted (OPENED) when the bimetallic disc reaches its preset temperature. The contacts will automatically reset once the electrospindle cools to a safe predefined level.

## 5. TRASPORT AND MOVING

### 5.1. PACKAGING AND LIFTING

- Lifting and moving the electrospindles can create situations of risk to persons nearby. Always follow the instructions provided by this manual, follow all possible safety instruction for the handling of heavy loads. Always use suitable lifting equipment. The responsibility for the safety of the people involved in handling, moving and lifting operation is of the customer.
- Installation and assembly work must be performed only by specialist technicians.
- Always use great care in lifting and moving electrospindles and their components. Avoid impacts which can damage the body or the shaft or the bearings of the electrospindle.



**IT IS THE RESPONSIBILITY OF THE CUSTOMER TO ENSURE THAT THE LIFTING EQUIPMENT USED IS SUITABLE FOR THE PURPOSE IN TERMS OF FUNCTIONING AND LOAD CAPACITY.**

**NEVER LIFT THE ELECTROSPINDLE BY ITS FAN COVER. THIS CAN BREAK, DAMAGING THE ELECTROSPINDLE AND POSSIBLY CAUSING PERSONAL INJURY.**

**NEVER DRILL PARTS OF ELECTROSPINDLE TO ATTACH ELEMENTS USEFULL TO MOVE ELECTROSPINDLE.**

### Load characteristics

The load is to be considered too heavy for a single person when:

- It weights for more than 30 kg for men
- It weights for more than 20 kg for women

Do not drill the electrospindle to fit any hoisting tool.

### 5.2. STORAGE

If the electrospindle is to be stored for any length of time, make sure that it is protected against the elements and in particular against damp, dust, and other forms of damage by the atmosphere or storage environment.

**STORAGE TEMPERATURE: from -5°C to +55°C**  
**NON-CONDENSING RELATIVE HUMIDITY: from 5% to 15%**



**THE STORAGE TIME OF TEKNOMOTOR ELECTROSPINDLE IS 12 MONTHS. AFTER THIS TIME-LIMIT THE PRODUCT MUST BE INSPECTED BY AN AUTHORIZED TEKNOMOTOR SERVICE. PLEASE CONTACT TEKNOMOTOR S.R.L. IF YOU NEED MORE INFORMATION.**

## 6. INSTALLATION

### 6.1. CHECKING FOR DAMAGE

Before starting installation, check:

- That no part of electrospindle has been damaged during transport and/or handling,
- That there is no sign of damp or water inside the connection terminal board,
- That the terminal board and its cover are not damaged in any way.



**IF THE ELECTROSPINDLE IS DAMAGED INFORM IMMEDIATELY THE TRANSPORTER AND TEKNOMOTOR S.R.L.**

### 6.2. PROVISION OF ON SITE INSTALLATION EQUIPMENT

All work in preparation for installation of the electrospindle is the responsibility of the customer (e.g. preparation of electrical power supplies, compressed air etc.).

Make sure that the electrical power line to the electrospindle is of adequate section and power. Connection of the unit to the power supply must only be done by qualified electricians. The customer is responsible for all parts of the electrical power supply to the electrospindle.



**ATTENTION: THE COSTUMER IS EXPRESSLY REMINDED THAT THE ELECTROSPINDLE MUST BE CORRECTLY CONNECTED TO EARTH. FURTHERMORE, THE EARTH CONNECTION MUST COMPLY WITH APPLICABLE REGULATIONS IN THE COUNTRY IN WHICH THE UNIT IS INSTALLED AND MUST BE DULY CHECKED AND TESTED BY A QUALIFIED ELECTRICIAN.**



### 6.3. RUNNING IN

The electrospindle is running in the factory prior to shipment. This ensures correct distribution of the long-life grease in the bearing races. The running in cycle also includes comprehensive testing of all electrospindle electrical mechanical parts.



It is necessary the electrospindle will be running in before it works:

- Step 1: run the electrospindle at a speed of 3000 rpm for 2 minutes;
- Step 2: increase the speed of 3000 rpm every 2 minutes up to the maximum speed written on the name plate of electrospindle.

Check the temperature of electrospindle nose, if it exceeds the 50°C stop the electrospindle. Restart the running in from the last speed when the electrospindle temperature reaches the ambient temperature.

### 6.4. FIXING THE ELECTROSPINDLE

The electrospindle must be fixed to the machine carriage or support by means of bolts. Maximum penetration of bolts from the support plate must be shorter than the holes. See the overall dimension drawings.

	<p><b>EXCESSIVE BOLT PENETRATION CAN CAUSE DEFORMATION OF THE ELECTROSPINDLE'S BODY, AND MECHANICAL OR ELECTRICAL DAMAGE THAT CAN LEAD TO SPINDLE MALFUNCTIONING.</b></p> <p><b>FIXING BOLTS MUST BE TIGHTENED WITH A TORQUE WRENCH.</b></p> <p><b>IT IS VERY IMPORTANT TO RESPECT THE TIGHTENING TORQUE SPECIFICATION, ESPECIALLY WHEN INSTALLING ELECTROSPINDLES ON WHICH ONLY A LIMITED LENGTH OF BOLT CAN BE SCREWED INTO THE FIXING HOLES. FIXING BOLT TIGHTENING TORQUE MUST BE DETERMINED BY THE CUSTOMER ON BASIS OF ELECTROSPINDLE TESTS IN THE MACHINE IN WHICH IT IS TO BE INSTALLED.</b></p> <p><b>EFFECTIVE TIGHTENING TORQUE CAN VARY SIGNIFICANTLY UNDER THE EFFECT OF FRICTION, THE PRESENCE OF GREASE, AND THE SPEED AT WHICH TIGHTENING IS DONE.</b></p>
	<p><b>TIGHTENING TORQUE MUST BE DETERMINED TO SUIT THE APPLICATION TO WHICH THE ELECTROSPINDLE IS TO BE PUT.</b></p> <p><b>WHILE FIXING THE UNIT IN PLACE, TAKE CARE NOT TO BLOCK OFF THE COOLING FAN GRILL OR OTHERWISE IMPEDE THE FLOW OF COOLING AIR. ALWAYS LEAVE THE MAXIMUM GAP AROUND THE UNIT SPECIFIED IN THE OVERALL DIMENSION DRAWINGS.</b></p>

### 6.5. ELECTRICAL CONNECTIONS

See data sheet and inverter configuration.

	<p><b>ATTENTION: ALWAYS USE POWER CABLE OF ADEQUATE CROSS SECTION FOR THE RATED CURRENT OF THE ELECTRIC MOTOR.</b></p> <p><b>NEVER FIT OR REMOVE CONNECTORS WITH THE ELECTROSPINDLE POWERED ON.</b></p>
---	---



#### Protections for electric motor

All electrical circuits must be protected against damage resulting from faults or malfunctions due to: short-circuit overloads; overload current; interruption or reduction of the supply voltage; excessive speed of machinery components; overheating in case of a high number of on-load starts. For the safety of people and/or objects, protections must be provided against direct contact with live parts and indirect contact with parts which are not live under normal conditions but which may become so in the event of a fault. If the motor shaft stops because of current cut off, it is recommended to take precautions for the stop of the rotation in the opposite direction; if the safety of the machine depends on the direction of the motor shaft, it is recommended to take precautions to avoid an inversion of the phases; in case, the direction of rotation must be indicated with a visible label.

See the inverter manual to determine the kind protections of short-circuit overcurrents and overload currents.

### 6.6. ELECTRIC FAN

In some version the electrospindle is cooled by a rear mounted electric fan. The fan must be powered up even when the spindle is not operating. The fan is independent of the spindle shaft. This solution gives improved efficiency compared to shaft mounted fans.

	<p><b>THE FAN MUST REMAIN ON AT ALL TIMES WHEN THE MACHINE IS ACTIVE EVEN IF THE ELECTROSPINDLE IS NOT OPERATING.</b></p>
	<p><b>THE VOLTAGE OF THE ELECTRIC FAN IS PRINTED ON THE ELECTROSPINDLE NAME PLATE.</b></p>

## 7. GENERAL CHECKS AFTER INSTALLATION IN THE MACHINE AND PRIOR START-UP

### 7.1. CHECKING ON THE ELECTROSPINDLE PRIOR TO START-UP

#### Positioning

- Make sure that there is sufficient space behind the electrospindle cooling grill, at least 100mm.

#### Electrical connections

- Make sure that the electrospindle earthing cable or earthing terminal is connected to the machine earth.
- Make sure that the signal from the motor's PTC thermistor or bimetallic protection is suitably processed and connected in series with the machine's stop circuit.

#### Programming the inverter

- Make sure that the maximum supply voltage value corresponds to that specified on the electrospindle motor data plate (see section 2.5).
- Make sure that the frequency value at maximum voltage corresponds to that specified on the electrospindle motor data plate (see section 2.5).
- Make sure that the maximum frequency value corresponds to that specified on the electrospindle's motor data plate (see section 2.5).
- The inverter must be programmed with the ratio V/f constant.
- Contact Teknomotor S.r.l. if you need to check other inverter parameters.

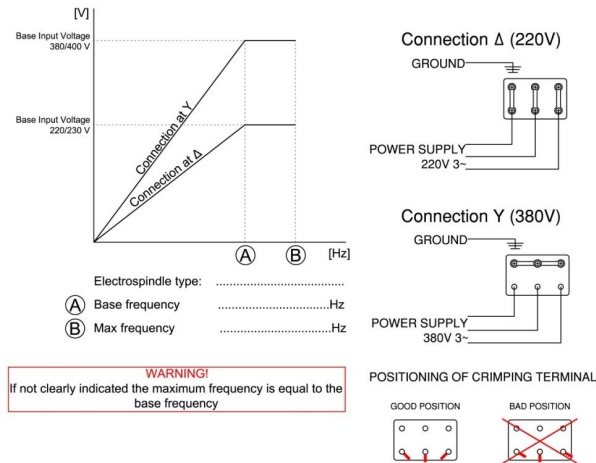

Frequency-Voltage diagram and cabling



**ATTENTION: WRONG INVERTER SETTING COULD CAUSE INSTANTANEOUS DAMAGE ON THE ELECTROSPINDLE.**

## 7.2. CHECKING ON THE ELECTROSPINDLE AT THE TIME OF FIRST START-UP

- Check the direction of rotation of spindle shaft corresponds with the NC and with the direction symbol on the body of the electrospindle; the wrong direction of rotation of spindle shaft causes unscrewing of nut or bolt.
- Run the electrospindle briefly without load to warm it up (see section 8.2)
- Make sure that the draft of cooling air produced by the fan comes out from all four air channels in the nose of the spindle.

## 8. OPERATION OF THE ELECTROSPINDLE

### 8.1. CLIMATIC LIMITATIONS

Unless specified otherwise, all Teknomotor electrospindles are designed to operate within the following ranges:

- Altitude not above 1000 m above sea level
- Maximum ambient air temperature not above 40°C
- Minimum ambient air temperature not below 10°C

### 8.2. FORECAST AND NON FORECAST USE

Teknomotor electrospindles have been designed to be mounted on a machine tool for the chips removal; it is the customer's responsibility to have any necessary interventions carried out on said machinery in order to render it compliant with Directive 98/37 EC.

The electrospindle can only be used if the machine on which it is going to be mounted has been rendered compliant with Directive 98/37 EC.

Use the electrospindle only to machine materials specified to Teknomotor when placing the order to avoid any inconvenience whatsoever. Generally the electrospindle can not work in foggy environments or with coolant jet directly in the spindle nose. Specific pneumatic sealed electrospindle are available for such environments (contact our technical office for more information).

Teknomotor S.r.l. declines all responsibility for non-compliance of the electrospindle caused by failure to follow the precautions and instructions given in this manual or by improper use or handling of the electrospindle.

#### Forecast use:

- Use the electrospindle only for working materials specified at order placement, in general wood, pvc, aluminum.
- Always use sharpened and balanced tools.
- Always use extra precision collets.

#### Non forecast use:

- Never use the electrospindle in foggy environments or with coolant jet in the spindle nose.
- Never use the electrospindle with too heavy or too long tools
- Before starting the electrospindle always fix it to the machine tool chassis. Never use the electrospindle as a manual tool.
- Never run the electrospindle faster than the maximum speed written on the electrospindle name plate.
- Never run the electrospindle faster than the maximum speed written on the tool body.

In case of any doubt regarding the correct use of electrospindle do not hesitate to contact our technical office.

### 8.3. WARMING UP

Every day, when the electrospindle is started up for the first time, leave it warm up slowly without load. This ensures that the bearings reach their running temperature gradually, and that the bearing races expand evenly.

The following warming up cycle is recommended:

50% maximum plated speed for 5 minutes.

Warm the electrospindle up before machining whenever the machine has been left idle long enough for it to cool down to ambient temperature.

### 8.4. CHOOSING TOOLS

Bear in mind the following recommendations when choosing tools:

- 1) Use only fully sharpened tools, and make sure that they are securely locked in the spindle.
- 2) Never use bent or damaged tools, chipped tools, or tools that are not perfectly balanced.
- 3) Do not exceed the speed marked on the tool body or specified in the tool user manual.
- 4) Always ensure that the following essential requisites are met before using any tool at high speed:
  - The tool must be of compact, short, and lightweight design
  - The tool must be a precision instrument, and any inserts must be held into a high degree of security
  - The tool must be balanced and must mate symmetrically with the tool holder
  - The cutting surfaces of the tool must be located near its centre of rotation

	<b>THE RECOMMENDED BALANCING DEGREE FOR TOOLS EXCEEDING THE SPEED OF 6000 RPM IS G2.5 (ISO 1940 STANDARD).</b>
	<b>FOR ELECTROSPINDLE WITH CONICAL SEAT FOR ER DIN 6499</b> <b>IF THE TOOL PROTRUSION IS LONGER THAN 80MM USE ABSOLUTELY EXTRA PRECISION COLLETS. PLEASE CHECK SECTION .8.6. OF THIS BOOK.</b>
	<b>FOR ELECTROSPINDLE WITH CILINDRICAL SHAFT</b> <b>UNLESS OTHERWISE REQUESTED BY THE CUSTOMER, ELECTROSPINDLE WITH TOOL ENGAGEMENT KEY ARE BALANCED WITH THE KEY IN PLACE (FULL KEY BALANCING – FK).</b>

Because of the many factors to consider, it is not possible to summarize in table form the diameters and maximum weights of tools for any specific speed.

	<b>ALWAYS CHECK THE MAXIMUM OPERATING SPEED OF TOOLS. THIS IS EITHER PUNCHED ON THE TOOL ITSELF OR OTHERWISE SPECIFIED BY THE TOOL MANUFACTURER.</b>  <b>DURING MACHINING, TAKE GREAT CARE TO AVOID CONTACT BETWEEN NON-CUTTING ROTATING PARTS (SPINDLE SHAFT, TOOL RING NUT, ETC.) AND THE WORKPIECE OR OTHER PARTS OF THE MACHINE. ACCIDENTAL CONTACT CAN LEAD TO DAMAGE TO THE ELECTROSPINDLE OR INJURY TO THE OPERATOR.</b>  <b>NEVER START ELECTROSPINDLE FITTED WITH TOOL ENGAGEMENT KEYS WITHOUT A TOOL IN PLACE AND CORRECTLY TIGHTENED IN THE TOOL HOLDER.</b>
--	---

### 8.5. TOOL MOUNTING – ELECTROSPINDLE WITH CONICAL SEAT FOR ER DIN 6499

The tool mounting is a careful operation because it define the electrospindle life.

	<b>EXCESSIVE TOOL RUN-OUT CAUSES PREMATURE WEAR OF BEARINGS.</b>
--	--

Before fixing the tool on the electrospindle:

- Carefully blow with compressed air the inside taper, the nut, the collet and the tool.
- Clean them with mix thinner-oil (92%+8%) to remove the processing residual if it is necessary use soft paper.
- Fix the collet on the nut and check that it could turn freely.
- Insert them into the inside taper of the electrospindle and screw the nut by hand.
- Insert the tool and check that it could axially move freely.
- Position the tool in order that the collet clamps the tool on the total length of contact.
- Screw the nut with the advised torque using the specific wrench.
- Check the run out of the tool or if it is not possible check the vibration level of the motor.

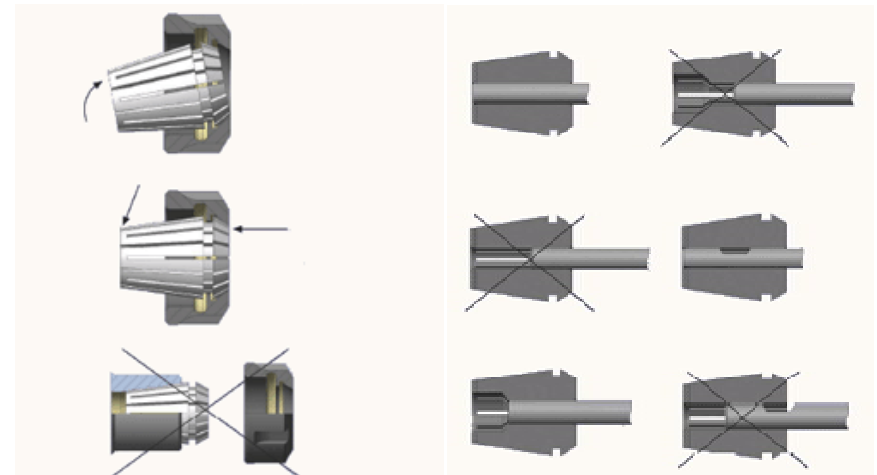

### 8.6. MAXIMUM RUN-OUT AND VIBRATION VALUES

Check that the tool is aligned with the shaft. Use a dial gauge with high resolution (0.001 mm) to measure the tool run-out. The maximum allowed run-out is 0.02mm @ 100mm far from the collet (L1). If it is not possible to measure the tool run-out because of the tool design, use a vibrometer to check the vibration level of the motor. The maximum vibration value should not exceed 2.0-2.5mm/s.

The concentricity values according to DIN 6388 are shown on the following table:

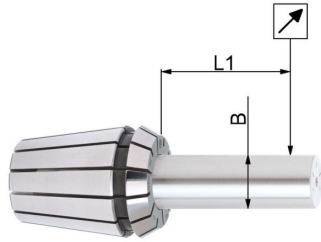

Concentricity collets values				
Ø B mm		L1 mm	DIN6388 mm	Extra precise mm
da	a			
1.0	1.6	6.0	0.015	0.005
1.6	3.0	10.0	0.015	0.005
3.0	6.0	16.0	0.015	0.005
6.0	10.0	25.0	0.015	0.005
10.0	18.0	40.0	0.020	0.005
18.0	26.0	50.0	0.020	0.005

The run-out values of 3 type of collets on the market are shown on the following table:

MEASURED RUN OUT OF GRINDED PIN Ø20mm WITH ER32 COLLET			
Distance between collet and measurement point L1	Collet low quality	Collet medium quality	Collet high quality (extra precise)
90mm	120µm	70µm	20µm

In the same way the vibration values of the motor with 3 different types of collet on the market are shown on the following table:

MEASURED VIBRATION VALUES OF THE MOTOR WITH ER32 COLLET AND GRINDED PIN Ø20mm 360g			
rpm	Collet low quality	Collet medium quality	Collet high quality (extra precise)
12000	3.0 mm/s (front) 3.2 mm/s (rear)	2.0 mm/s (front) 1.1 mm/s (rear)	0.7 mm/s (front ) 0.3 mm/s (rear)
18000	4.2 mm/s (front) 4.6 mm/s (rear)	3.3 mm/s (front) 2.0 mm/s (rear)	1.3 mm/s (front) 0.5mm/s (rear)

The experimental results underline that a heavy tool as a milling tool (Ø 16 mm used on the door machine) needs an extra precise collet. Excessive tool run-out causes a premature wear of the rear bearings as clearly shown on the above table.

<b>i</b>	<b>USE EXTRA PRECISE COLLETS TO GUARANTEE A LONG LIFE OF YOUR ELECTROSPINDLE.</b>
----------	---

### 8.7. TOOL MOUNTING – ELECTROSPINDLE WITH CILINDRICAL SHAFT

The tool mounting is a careful operation because it define the electrospindle life.

<b>!</b>	<b>EXCESSIVE TOOL RUN-OUT CAUSES PREMATURE WEAR OF BEARINGS. THE MAXIMUM VIBRATION LEVEL SHOULD NOT EXCEED 2.0 -2.5 MM/S</b>
----------	--

Before fixing the tool on the electrospindle:

- Carefully blow with compressed air the shaft, the nut and the tool.
- Clean them with mix thinner-oil (92%+8%) to remove the processing residual if it is necessary use soft paper.
- Screw the nut or the screw with the advised torque using the specific wrench.
- Check the vibration level of the motor.

<b>!</b>	<b>CHECK THAT THE TYPE OF BALANCING OF THE MOTOR MATCH WITH THE BALANCING OF THE TOOL:</b>
	<ul style="list-style-type: none"> <li>- FOR MOTOR BALANCED WITH FULL KEY (FK) USE A TOOL WITH TWO SLOTS.</li> <li>- FOR MOTOR BALANCED WITH HALF KEY (HK) USE TOOL WITH ONE SLOT.</li> </ul>

<b>!</b>	<b>A WRONG COUPLING OF MOTOR AND TOOL BALANCING CAN CAUSE A PREMATURE BEARING FAILURE.</b>
----------	--

<b>!</b>	<b>A WRONG COUPLING OF MOTOR AND TOOL BALANCING CAN PROVOKE SERIOUS INJURIES OR DEATH.</b>
----------	--

### 8.8. DIFFERENT KIND OF TOOLS

When placing an order it is fundamental to ask for the correct type of balancing to avoid any excessive vibration when the motor is coupled with the tool. **A wrong match between tool and motor shaft causes vibrations which can compromise the finishing grade of the part as well as considerably reduce the motor life.**

<b>i</b>	<b>DIFFERENT KIND OF TOOLS REQUIRES DIFFERENT KIND OF SHAFT BALANCING.</b>
----------	--

#### Tool with one slot

This kind of tool requires a half key balancing (HK) shaft. In this case there are two asymmetrical and unbalanced rotating parts (motor shaft and tool) which will be matched together. If correctly designed the matching will define a balanced system.

Some important point to be considered are:

- Equal length between tool (or tool + spacer) and keyway.
- Minimum gap between shaft keyway and the tool (gap=A-B< 0.5mm)
- Same density of tool body and shaft key [kg/dm<sup>3</sup>].
- Respect of the coupling tolerances (Ø<sub>tool</sub>-Ø<sub>shaft</sub> < 0.02mm)

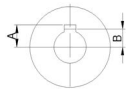

**Tool with two slots**

This kind of tool requires a full key balancing (FK) shaft or a shaft with two symmetrical keyways (suggested option). In this case there are two symmetrical and balanced rotating parts (motor shaft and tool) which will be matched together. The correct matching is independent from the length of the keyways/tool. It is independent from the gap and from the density of the tool body



The only important point to be considered is:

- Respect of the coupling tolerances ( $\varnothing_{\text{tool}} - \varnothing_{\text{shaft}} < 0.02\text{mm}$ )

**Tool with no slots**

This kind of tool requires a plain shaft. In this case the torque is transmitted by friction. The correct matching is independent from the length of the shaft/tool. It is independent from the density of the tool body



The only important point to be considered is:

- Respect of the coupling tolerances ( $\varnothing_{\text{tool}} - \varnothing_{\text{shaft}} < 0.02\text{mm}$ ).
- Respect of the versus of the locking thread nut. If, looking from the front, the motor rotate clockwise the thread should be counterclockwise. If the motor rotate counterclockwise the thread should be clockwise.

	<b>TEKNOMOTOR S.R.L. DOES NOT ASSUME ANY RESPONSIBILITY FOR THE GIVEN SUGGESTIONS ABOUT THE TOOL CHOOSING, COUPLING AND LOCKING. ANY RESPONSIBILITY IS OF THE DESIGNER AND MANUFACTURER OF THE MACHINE.</b>
	<b>TOOLS ROTATING AT HIGH SPEED ARE VERY DANGEROUS. THEY CAN BE EJECTED FROM THE MACHINE AND SERIOUSLY INJURY OR EVEN KILL PEOPLE. EVEN OBJECTS, CHIPS AND OTHER POTENTIALLY DANGEROUS PARTS CAN BE EJECTED. THE MACHINE MUST HAVE A STRONG CLOSED HULL CORRECTLY DESIGNED TO PROTECT THE PEOPLE FROM ANY RISK ASSOCIATED TO HIGH SPEED ROTATING TOOLS EVEN IN CASE OF AN ELECTROSPINDLE FAILURE.</b>

If you have any doubt or you need any clarification do not hesitate to contact our technical office.

**9. MAINTENANCE**

Read this section carefully before attempting any maintenance on the electrospindle. This section contains information that is important for the safety of maintenance personnel and for the reliability of maintenance work itself.

All applicable safety precautions must be taken whenever maintenance work is done on the electrospindle. In particular:

- Maintenance and/or lubrication must be performed only by qualified, expert personnel, with the authorization of factory management, in compliance with applicable safety directives and standards, and with the use of suitable tools and instruments.

- When performing maintenance, always wear suitable clothing such as tight fitting work overalls and safety shoes. Never wear long or slack clothing or clothes with parts that hang loose.
- When performing maintenance on a machine, cordon it off and mark it clearly with panels stating "MACHINE UNDERGOING MAINTENANCE".

During all maintenance work make sure that the electrospindle is:

- disconnected and insulated from the electrical power supply;
- fully stopped (not still spinning).

Maintenance managers must ensure that their team is trained to ensure optimum coordination and safety. All persons performing maintenance must remain fully visible to colleagues at all times so that they can signal for assistance if necessary.

	<b>USE ONLY SUITABLE LIFTING AND MOVING EQUIPMENT TO DISCONNECT OR REMOVE HEAVY PARTS FROM THE MACHINE.</b>
	<b>SPECIAL TOOLS ARE NOT NORMALLY REQUIRED FOR ELECTROSPINDLE MAINTENANCE.</b>

**9.1. SCHEDULED MAINTENANCE AND CLEANING THE SPINDLE SHAFT TOOL HOUSING**

Always keep the tool housing in the spindle shaft perfectly clean and free from dust, grease, coolant, oil, metal shavings, and corrosion or lime scale.

Dirty housings cause incorrect tool seating, misalignment with respect to the spindle's axis of rotation, and tool slippage (on models without a key). Dirt can also damage the surface of the housing, causing poor machining precision, and causing risk of injury to operating personnel.

For this reason, check at every tool change for the manual tool changing spindles and at least once a day for the automatic tool changer electrospindle that the surfaces of the spindle shaft, taper, tool housing and tool itself are perfectly clean.

These parts can be cleaned using standard commercial detergents for metal surfaces. When cleaning, take the opportunity to check the condition of the surfaces for wear or damage.

**9.2. OCCASIONAL MAINTENANCE**

Clean the grill of the cooling fan and remove any objects blocking the airways and control the fixing screws.

	<b>THE BEARINGS ARE LUBRICATED FOR LIFE AND DO NOT REQUIRE GREASING.</b>
--	--

Component parts must be removed and refitted only by qualified personnel authorized by Teknomotor S.r.l.



**ONLY REPLACEMENT OF PARTS WITH ORIGINAL TEKNOMOTOR SPARES AND THE SUBSEQUENT ADJUSTMENT OF THE NEWLY FITTED PARTS IS AUTHORIZED. NO OTHER TYPE OF WORK IS AUTHORIZED AND, IF DONE, WILL LEAD TO THE CANCELLATION OF THE WARRANTY. PLEASE CONTACT TEKNOMOTOR S.R.L. IF YOU NEED MORE INFORMATION.**

## 10. TROUBLESHOOTING

PROBLEM	PROBABLE CAUSE	CORRECTIVE ACTION
<b>Excessive vibration during machining</b>	<ul style="list-style-type: none"> <li>• Unbalanced tool.</li> <li>• Incorrectly fitted tool.</li> <li>• Excessive cutting parameters.</li> <li>• Incorrect inverter settings.</li> <li>• Tool too big or too heavy.</li> </ul>	<ul style="list-style-type: none"> <li>• Balance the tool.</li> <li>• Check that the tool is correctly fitted.</li> <li>• Adjust (reduce or increase) the various cutting parameters.</li> <li>• Check the inverter settings.</li> <li>• Try machining with smaller tools.</li> </ul>
<b>Bearings noise</b>	<ul style="list-style-type: none"> <li>• Damaged bearings.</li> </ul>	<ul style="list-style-type: none"> <li>• Send the electrospindle to Teknomotor S.r.l.</li> </ul>
<b>The electrospindle get very hot and is stopped by the PTC thermistor signal</b>	<ul style="list-style-type: none"> <li>• Incorrect inverter settings.</li> <li>• Power settings too high.</li> <li>• Machining speeds too low for the power requirement.</li> <li>• Cooling fan grill blocked.</li> <li>• Cooling fan broken.</li> </ul>	<ul style="list-style-type: none"> <li>• Set the inverter parameters according to the plated values.</li> <li>• Contact the Teknomotor Technical Office.</li> <li>• Check the cooling fan grill and remove any blockage.</li> <li>• Replace the broken fan.</li> </ul>

## 11. DISPOSING OF THE ELECTROSPINDLE

At the end of the electrospindle's working life it is the customer's responsibility to dispose of it correctly. First of all, clean the unit and separate the various components into mechanical and electrical parts. Then separate the component parts according to type of material: electric motors (copper windings), metal parts (body, etc.), plastic parts, etc.. Dispose of the various materials in compliance with the laws and regulations applicable in the country where the electrospindle has been installed.

## 12. USEFULL ADDRESSES

Headquarters: Teknomotor S.r.l.  
Via Argenega, 19  
32030 Quero (BL)  
Italy

Tel. 0039 0439 787950  
Fax 0039 0439 780147

Website: [www.teknomotor.com](http://www.teknomotor.com)  
Sales: [info@teknomotor.com](mailto:info@teknomotor.com)  
Technical office: [tecnico@teknomotor.com](mailto:tecnico@teknomotor.com)  
Administration: [amministrazione@teknomotor.com](mailto:amministrazione@teknomotor.com)  
Purchase department: [acquisti@teknomotor.com](mailto:acquisti@teknomotor.com)